

NV51K7770DS

30" Double Wall Oven

Features

- 6 Oven Modes including Steam Bake and Steam Roast
- 5.1/5.1 cu. ft. Capacity
- Gourmet Cook
- Dual Convection
- Wi-Fi Connectivity
- Wi-Fi Enabled Temperature Probe
- LED Spotlights
- Soft-Close Door
- 6 Heavy-Duty Racks including 2 Gliding Racks
- Blue LED Illuminated Knobs
- Broil Element
- Smart Control Key
- 6 Rack Positions
- Drop-Down Door Design
- LCD Display

Convenience

- Hidden Heating Element
- Rapid Preheat
- Sabbath Mode
- Hybrid Clean and Self-Clean
- Delay Start
- Proofing
- Warming Mode
- Kitchen Timer
- Child Safety Lock
- Convection Conversion



Steam Cook



Flex Duo™

Available Colors



Stainless Steel (shown)



Black Stainless Steel

Signature Features

STEAM COOK

- Delivers moisture at precise times for a crisp, browned outside and tender inside.

FLEX DUO™

- Cook three dishes at different temperatures simultaneously with the Smart Divider.

DIGITAL-ANALOG CONTROLS

- The ultimate interface, a combination of analog-knobs and a digital touch screen.

NV51K7770DS

30" Double Wall Oven

Cabinet Dimensions

Double Oven Installed in Cabinet

*Junction Box

**Allow a minimum of 22" for clearance to adjacent corners, drawers, walls, etc. when door is open.

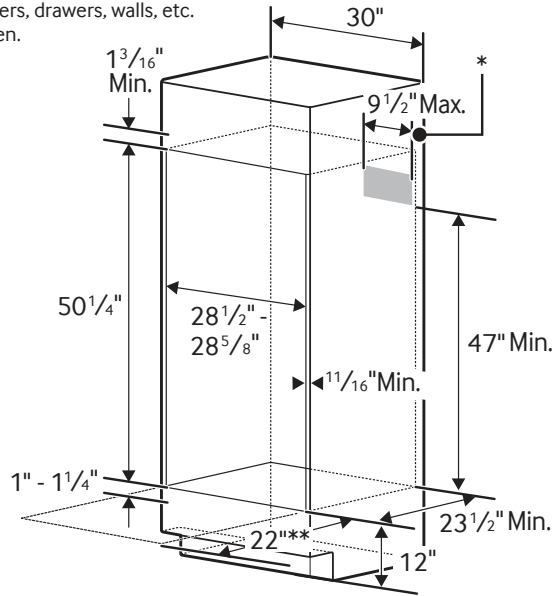

Product Dimensions

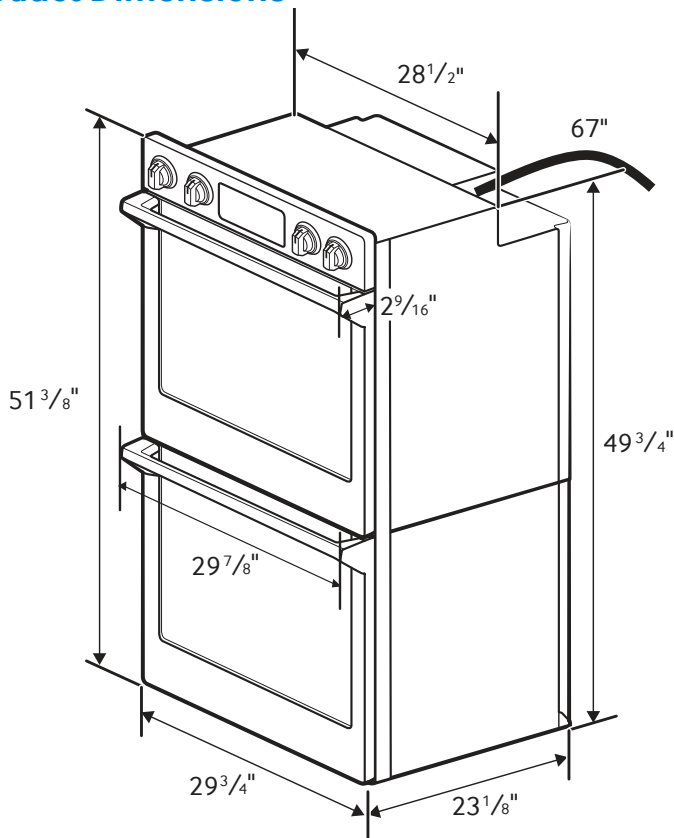

Total Capacity: 5.1/5.1 cu. ft.

Upper Oven: 5.1 cu. ft. total, 2.8/2.2 cu. ft.

Lower Oven: 5.1 cu. ft.

- Hidden Bake Element
- Bake: 175°F–550°F
- Convection Bake: 175°F–550°F
- Convection Roast: 175°F–550°F
- Broil: Low-High
- Steam Bake: 230°F–550°F
- Steam Roast: 230°F–550°F
- Proofing
- Sabbath Mode

Warranty

One (1) Year All Parts and Labor

Product Dimensions & Weight (WxHxD)

Outside (Max) Wall Oven Dimensions:

29 7/8" x 51 3/8" x 25 11/16"

Wall Oven Cut-Out Dimensions:

28 1/2" x 50 1/4" x 23 1/2"

Weight: 273.4 lbs.

Shipping Dimensions & Weight (WxHxD)

Dimensions:

33 1/2" x 56 3/8" x 29 13/16"

Weight: 306.4 lbs.

Color

Stainless Steel

Black Stainless Steel

Model #

NV51K6650DS

NV51K6650DG

UPC Code

887276181684

887276181677

KW RATING	
240V	10.6 kW
208V	8.0 kW
BREAKER SIZE	
240V	50 Amps
208V	40 Amps

SAMSUNG

Actual color may vary. Design, specifications, and color availability are subject to change without notice. Non-metric weights and measurements are approximate.

©2018 Samsung Electronics America, Inc. 85 Challenger Road, Ridgefield Park, NJ 07660. Tel: 800-SAMSUNG. samsung.com. Samsung is a registered trademark of Samsung Electronics Co., Ltd.